

Corotherm[®]

Polycarbonate Insulating Roofing Sheet

INSULATING ROOFING SYSTEM • IDEAL FOR CONSERVATORIES, PORCHES & GREENHOUSES • TEN YEAR WARRANTY

Installation (cont.)

Lay the final sheet with side flashing attached and secure the flashing apron to the wall. Fit the final glazing bar cap and complete the run of flashing.

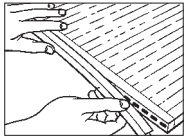

Finally, remove all protective film. To protect the breather tape which allows ventilation of the sheet, fit end caps at the lower end of the sheeting, with the rainwater drip downwards to lead run-off water into the gutter. Run a bead of sealant along the top edge of the end cap to prevent water ingress.

Note: All Corotherm sheets must have an expansion allowance of 3mm around all fixings and 3mm/metre for both the length and the width of the sheet. Mechanical fixing at the lower end of the sheet using a centrally positioned fixing button is recommended to prevent any downslope migration of the sheet.

Cleaning

Corotherm can be easily and quickly washed with luke warm soapy water and a soft cloth or sponge. Do not use brushes or sharp objects and avoid any abrasives or cleaners of a high alkaline nature.

HOW TO FIX

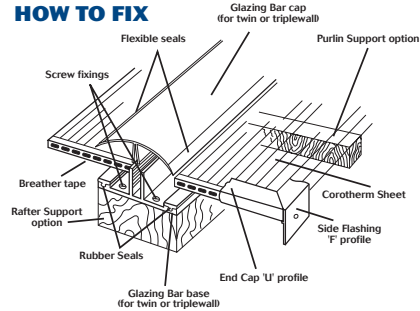

NB

- 1) Make sure LV protected side of sheet is facing outwards.
- 2) Allow minimum of 10° roof slope for water drainage.
- 3) The Ariel purlin supported glazing bar should be supported at intervals of no greater than 1500mm.
- 4) Rafter glazing bars should be fully supported by rafters.
- 5) The lines of the flutes on the sheet must only run from the top to the bottom of the slope. They cannot be run from side to side. Sheets cannot be joined top to bottom.
- 6) When using F section run a suitable low-modules silicone sealant down the inner top face of the enclosure before inserting sheet.

10 YEAR WARRANTY

ARIEL PLASTICS LIMITED undertakes to supply a replacement free of charge for any Corotherm Polycarbonate Sheet that proves to have discoloured, in normal weather conditions during a period of 10 years from the date of purchase due to a manufacturing defect.

This Warranty is only valid providing the Corotherm has been fixed in accordance with the manufacturer's instructions and does not extend to the cost of re-erection or other consequential loss, which claims are expressly excluded.

NOTE: All roofing materials may be prone to damage in areas exposed to particularly high winds or if fitted to structures which enhance the effects of prevailing wind. It is important therefore, that professional advice is taken before erection concerning prevailing winds and the structure planned.

This Warranty is offered as an extra benefit and does not affect your statutory rights.



Corotherm[®]

Polycarbonate Insulating Roofing Sheet

IDEAL FOR:

CONSERVATORIES
EXTENSIONS
SWIMMING POOL COVERS
ROOFLIGHT FEATURES

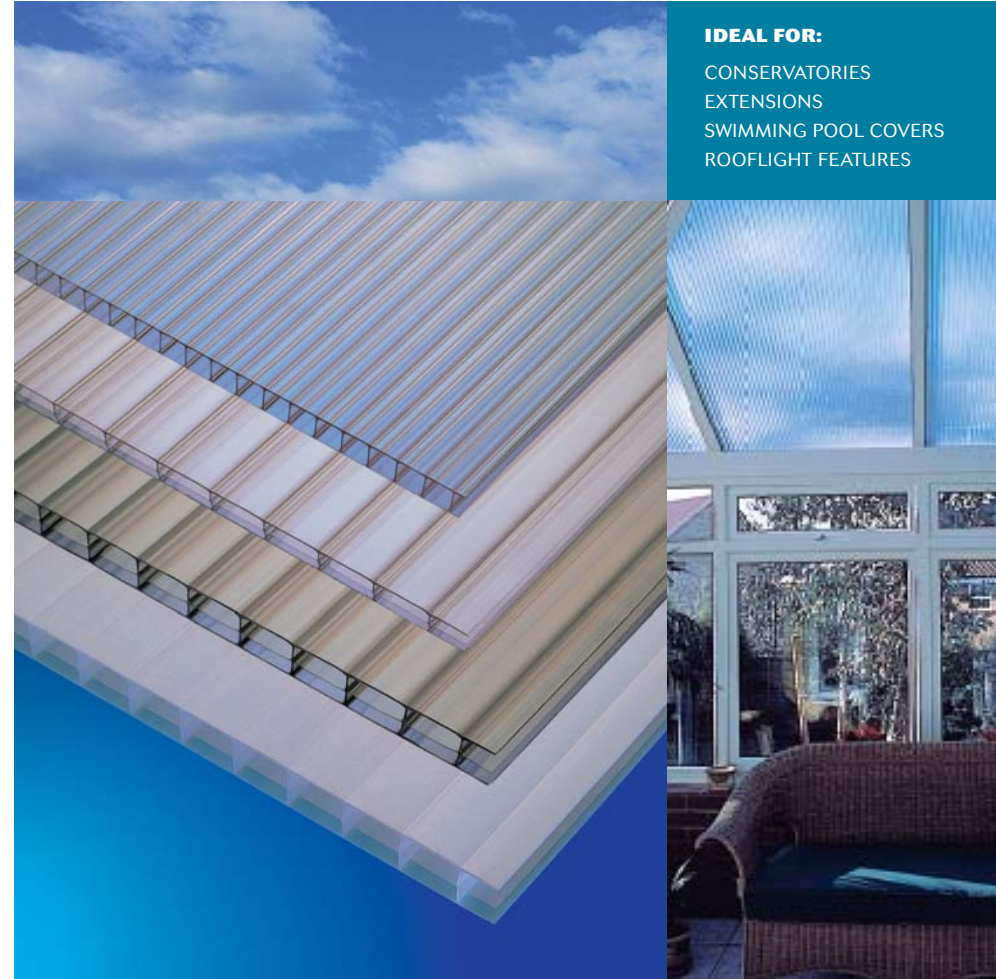

Speedwell Ind Estate Staveley Derbyshire S43 3JP Tel: 01246 561122 Fax: 01246 561111
Blairlinn Road Cumbernauld Glasgow G67 2TF Tel: 01236 725536 Fax: 01236 725871
Web Site: www.arielplastics.com



Builders Merchants Federation



Certificate No. Q98131

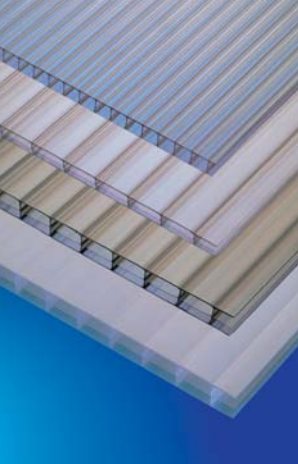

Corotherm Polycarbonate sheet is produced by an advanced manufacturing process giving the sheet the following important properties:

Ultra clear sheet

Also available in a range of tints

Strong and resistant to impact

Corotherm®

Polycarbonate Insulating Roofing Sheet

FEATURES

- Available in clear, bronze, opal and bronze opal
- Available in a wide range of thicknesses
- Very strong and resistant to impact fracture
- Fire rated 'Class 1' for safety
- Light in weight
- Thermally insulating
- Easy and quick to install
- Minimum condensation risk
- UV protected for durability
- Largely self-cleaning
- Guaranteed 10 year warranty
- Range of sheet sizes



APPLICATIONS

CONSERVATORIES
EXTENSIONS
CAR PORTS

PORCHES
SWIMMING POOL COVERS
ROOFLIGHT FEATURES

Wherever heat insulation, reduced condensation, or simply a more attractive glazing material is required



Corotherm®
Polycarbonate Insulating Roofing Sheet

FIXING INSTRUCTIONS

HOW TO INSTALL COROTHERM AS A LEAN-TO ROOF

Sheet Preparation

Once the glazing bar spacing has been calculated, according to the sheet thickness and means of support, it may be necessary to cut sheets to size.

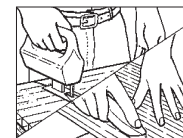

Corotherm can be cut very easily and will not crack or shatter. When cutting parallel to the flutes a sharp knife can be used but when

cutting across the flutes a fine toothed saw is required. For cutting curves, use a fine toothed jigsaw. Cutting dust may be removed by vacuum. If any dust is held in the flutes by static, simply leave the sheet until the static charge dissipates, then vacuum. Fix sealing tape at the top end of each piece of Corotherm and perforated breathing tape at the bottom.

In order to provide weather protection at the top of the slope, rake out the mortar joint immediately above the point at which the sheeting will meet the wall - this will be used for the top edge of a length of Ariel Aluminium or Butyl Flashing.

Glazing Bar Preparation

Rafter or Purlin Supported System - Carefully insert the bottom seals to avoid stretching. Working from one end press into place.

Ariel Rafter Supported Glazing Bar - Screw the bottom half of the glazing bar to the rafter at approximately 400mm centres

Ariel Purlin Supported Bar - Screw the bottom half of the glazing bar to every purlin ensuring the purlin spacing is not greater than 1500mm.

Use screws of suitable length usually half the depth of the support being used. Screws should be sealed in waterproof mastic, striking off any surplus after driving the screws.

Self Supporting System - Refer to the detailed fitting instructions supplied with the glazing bar components.

Flashing Preparation

Begin installation at one flank of the slope, by preparing a length of side flashing. The apron of

the side flashing should be pre-drilled to accept screw fixings and these holes should be 3mm oversize, to allow expansion and contraction of the flashing. In situations where the sheeting is to be installed abutting an end wall, the side flashing may be inverted so that the apron forms an upstand and finished using Ariel Aluminium or Butyl Flashing, stepped into the brickwork coursing.

Installation

Peel back the protective film from the edges of the first prepared sheet, ensuring that the sealing tape will be at the top of the slope and the perforated breathing tape is to the bottom of the slope. Run a bead of clear low-modulus silicone sealant into the prepared side flashing and push the sheet into

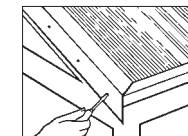

position with the printed film uppermost. At least one vertical rib of each Corotherm sheet should engage within the glazing bar. Attach the side flashing to the side of the roof, then check the important 3mm expansion clearance at the side of the sheet

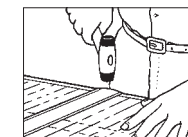

and a 10mm expansion gap at the top of the slope. Begin to install the flashing at this stage, carefully following the fixing instructions. Lay the second sheet in position then, starting at the downslope end, line up the ends of the cap and base and tap home with a rubber mallet, or woodblock and hammer until the edge seals have flattened against the sheet. Corotherm glazing bar caps have co-extruded integral sealing strips for permanent weather protection. Over driving the glazing bar cap may cause noise from the sheets as they expand and contract with temperature changes. Continue laying sheets and glazing bar caps in this manner until reaching the final sheet. Before installing this sheet press the second side flashing into place, using clear low-modulus silicone sealant as before.

Continued overleaf...

ariel®