

metrotile
LIGHTWEIGHT ROOFING

INSTALLATION GUIDE

IMPORTANT

These instructions are guidelines only and do not include all the appropriate equipment which should be used in accordance with safety regulations.
Please also note ROOFING FELT IS NOT ILLUSTRATED and should be fitted as required.

1 Tools required

Soft soled shoes, claw hammer, tape measure, snips, pencil and nails.



2 Attach Fascia Boards

Fix timber or UPVC fascia board. Top edge to be approximately a batten thickness above rafters.



3 Space and attach Battens

Batten spacings are crucial. They should be set out from front of batten to front of the batten above at 370mm except the first batten which will be 370mm less the overhang of the tile into the gutter, usually 40mm.

Note: 0.9 tiles usually fit better with a gauge of 365mm. For slate tiles use a gauge of 367mm.

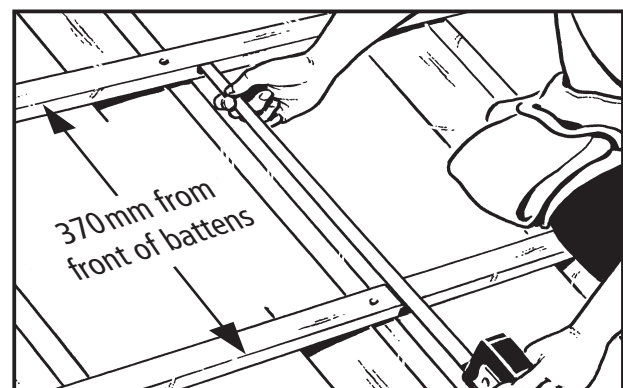
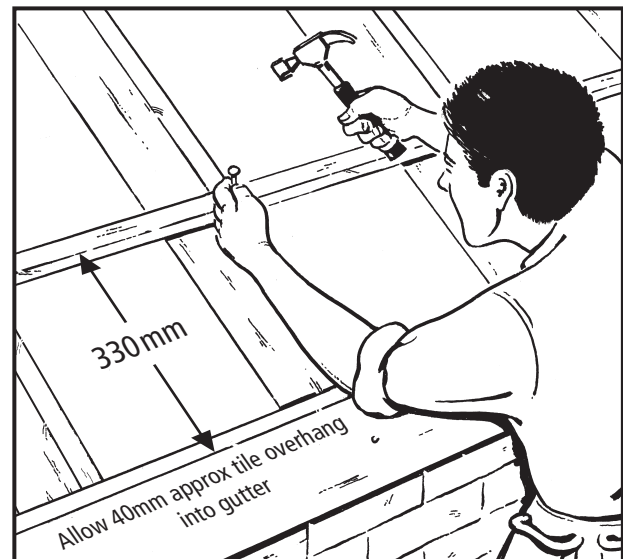

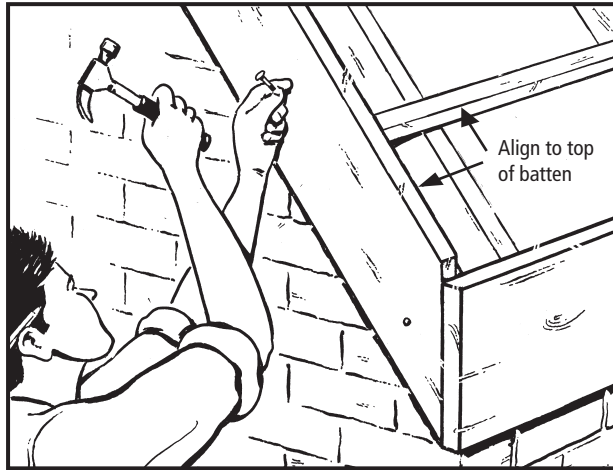

4 Attach Barge Board

Fix the timber or UPVC barge board with its top in line with the top of tiling battens.

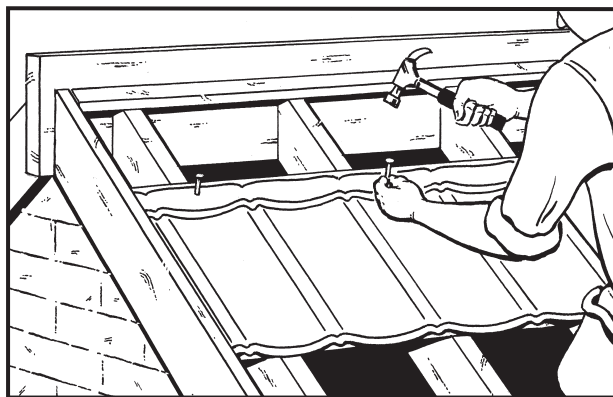

5 Attach first row of Tiles

Start nailing from the first full course down from the ridge. Put in a couple of nails in the top flange of the tile to hold it onto the batten. Lift the front edge of the tile and slide in the next tile down to lap under the top tile. Work along the roof, laying the tiles with the laps away from the line of sight or prevailing weather.

We would advise for aesthetic purposes, staggering the tiles (breaking the bond) when they are laid to avoid uniform lines down the roof. However, if tiles are not staggered, the strength or integrity of the roof will not be compromised.

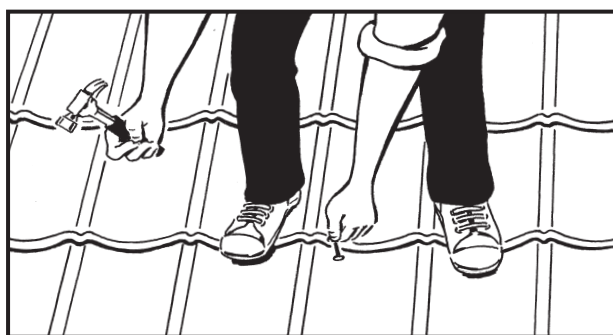

6 Nailing the Tiles

Stand on the nose of the tile (where the batten goes) and nail each tile in the front edge at its highest point (treading on the tiles keeps them nice and tight on the laps!).

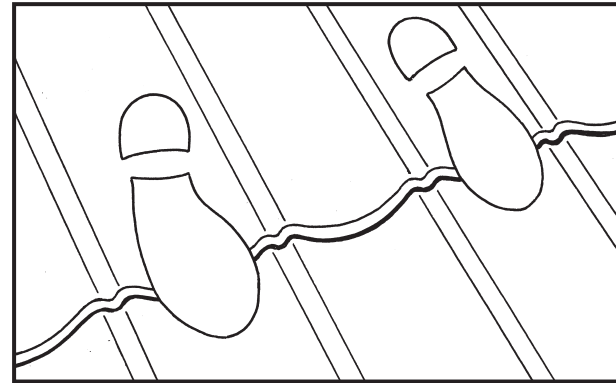

7 Stand on the nose of the Tiles

Do not tread on the middle of the tile or on the raised corrugations, always on the front edge in the pan, above where the batten is.

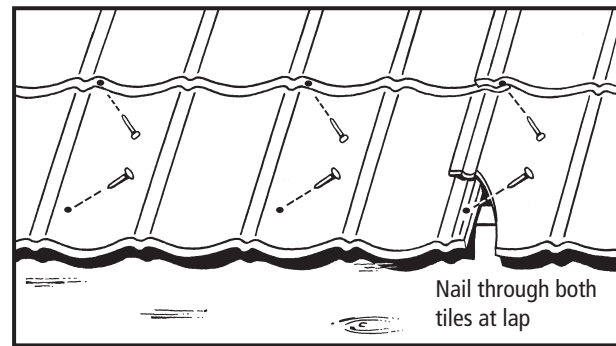

8 Nailing points

Attach nails as above. Cut-away shows correct lap of tiles.

FITTING TILES OR TOP COURSE AT THE RIDGE

Hopefully you will have a full course of tiles at the ridge. If not, measure the **gap A** at the ridge between the back of the top most course of tiles and the back of ridge batten.

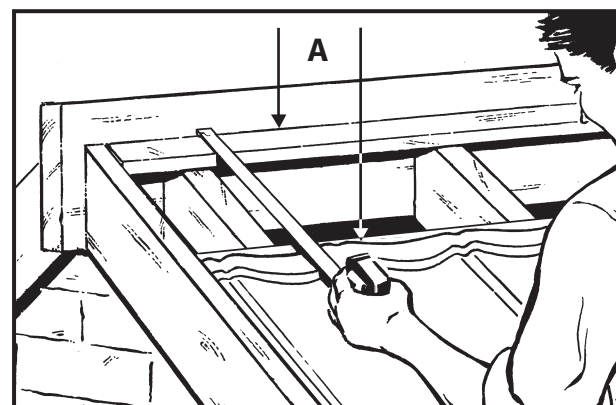

9 Measure the gap

If **gap A** measures **more than 200mm** you will need to fit **Tiles** by cutting and bending. See instructions 10 - 14.

If **gap A** is **less than 200mm** you will need to fit a **Top Course**. See instructions 15 and 16.

FITTING TILES AT THE RIDGE if gap A more than 200mm

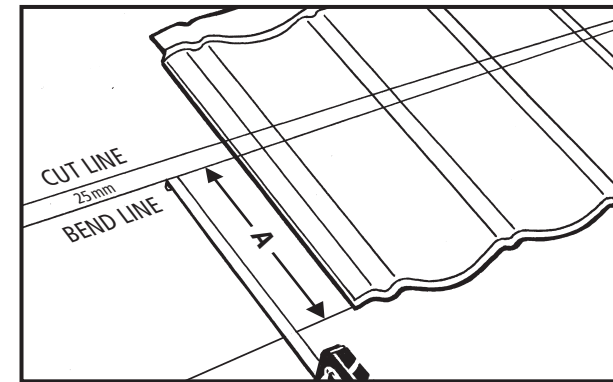

10 Marking Tiles for bending and cutting

Measure from the front of the tile and mark a line on the tile where your Bend Line is to be. Mark a line approximately 25mm above this, which will be your Cut Line (see 13).

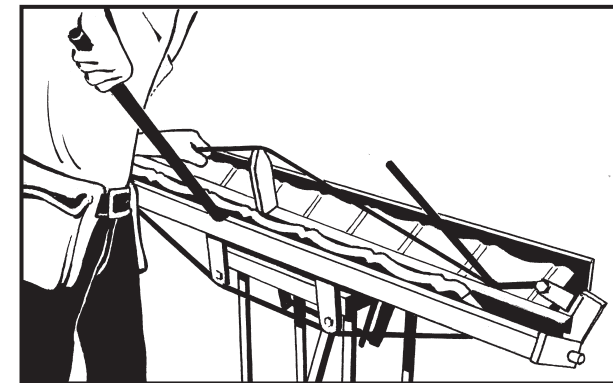

11 Bending Tiles

Always bend the tile first as its strength is in the nose and the rear upstand.

Bend the tile on the Bend Line using the bending equipment.

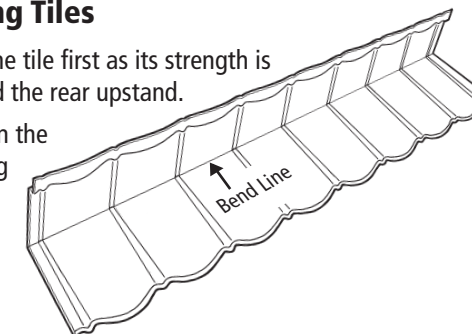

12 Bending Tiles for Hips and Valleys

Using the bending equipment bend the tiles upwards for Hips (see 20) and downwards for Valleys (see 21).

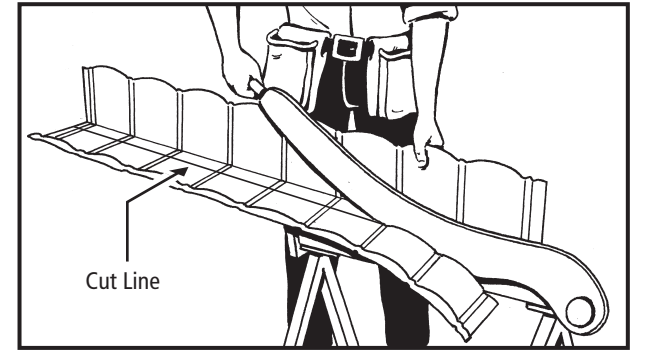

13 Cutting tiles using guillotine

Cut off waste along the Cut Line with guillotine. You can alternatively use snips if necessary.

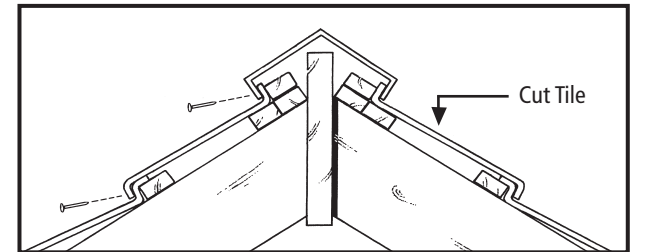

14 Ridge detail using pre bent Tile

Ridge detail and layout using pre bent tile.

FITTING A TOP COURSE AT THE RIDGE if gap A less than 200mm

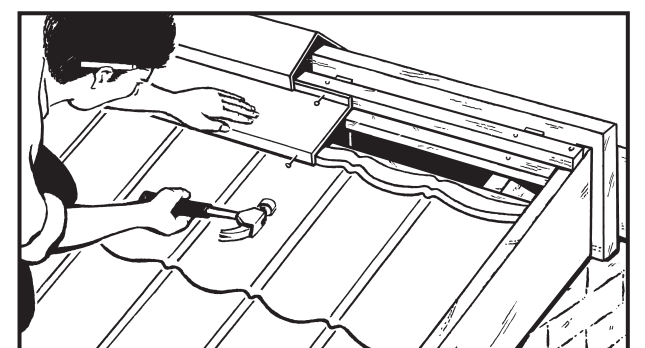

15 Attaching a Top Course

Cut and bend a top course to fit the gap and attach.

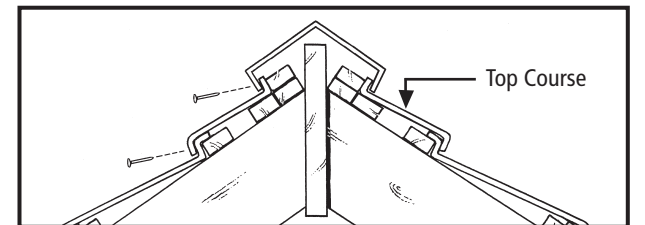

16 Ridge detail using Top Course

Ridge detail and layout using top course.

FITTING BARGE BOARD COVERS

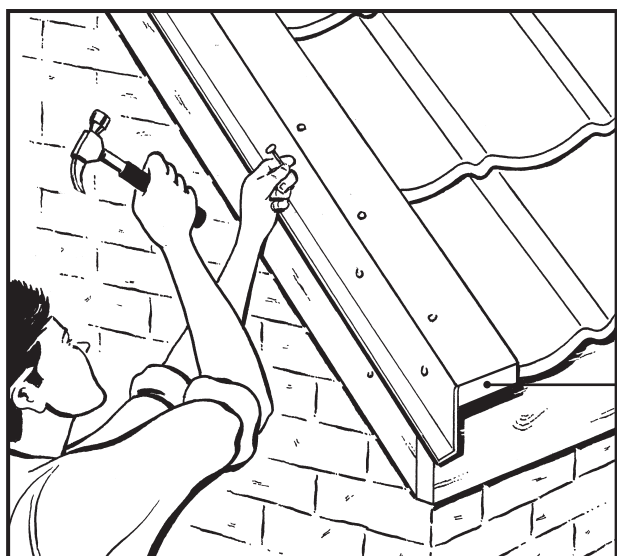

17 Attach Barge Board Covers

Measure and cut Barge Board Cover leaving overlap for finishing at end. Attach Barge Board Cover to barge board, nailing as shown in 18.

18 Nailing points for Barge Board Covers

Nail Barge Board Cover to barge board as shown

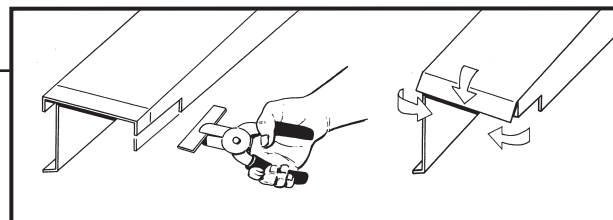
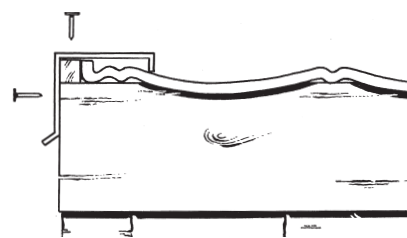

19 Finishing off ends

Finishing off Barge Board Cover ends can vary depending on the final look you required. Using snips cut and bend the cover as required making sure all corners and edges have underlapping flaps to make watertight.

FITTING TILES TO HIPS AND VALLEYS

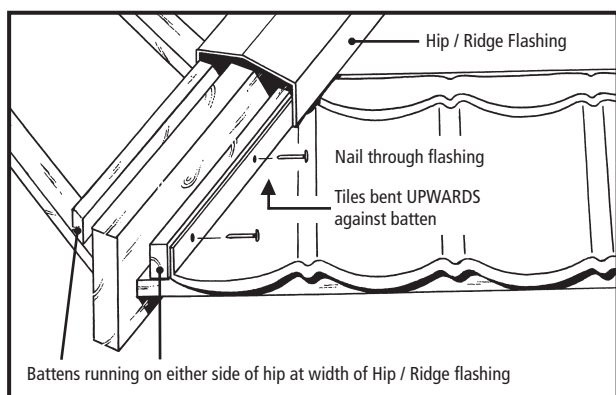

20 Fitting Tiles at Hips

Fix tile battens on either side of Hip (running up the length of the hip and approx 210mm apart measured from outside of batten to outside of batten) at the width of the hip flashing.

Tiles should be cut to the rake of the Hip and bent up against batten & fixed securely. Hip flashing should be then fixed by nailing through the flashing and into the battens through the upstand of the tiles using 2 nails per side.

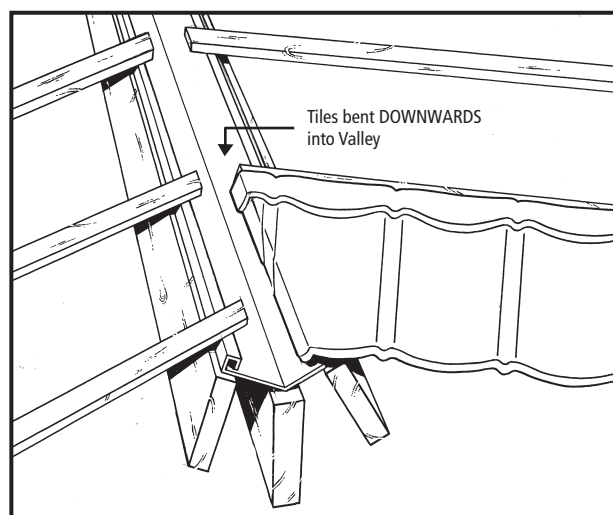

21 Fitting Tiles to Valleys

Tiles should be cut at the rake of the Valley (over hanging into the Valley gutter) and bend downwards into the Valley to prevent wind blown water. Tiles should be fixed into tiling battens as close to the Valley as possible.



metrotile
LIGHTWEIGHT ROOFING

Unit 3 Sheldon Business Park, Sheldon Corner, Chippenham, Wiltshire SN14 0RQ
Tel: +44 (0)1249 658514 Fax: +44 (0)1249 658453 Email: sales@metrotile.co.uk www.metrotile.co.uk